

Projekt Mebli do pokoju EA448

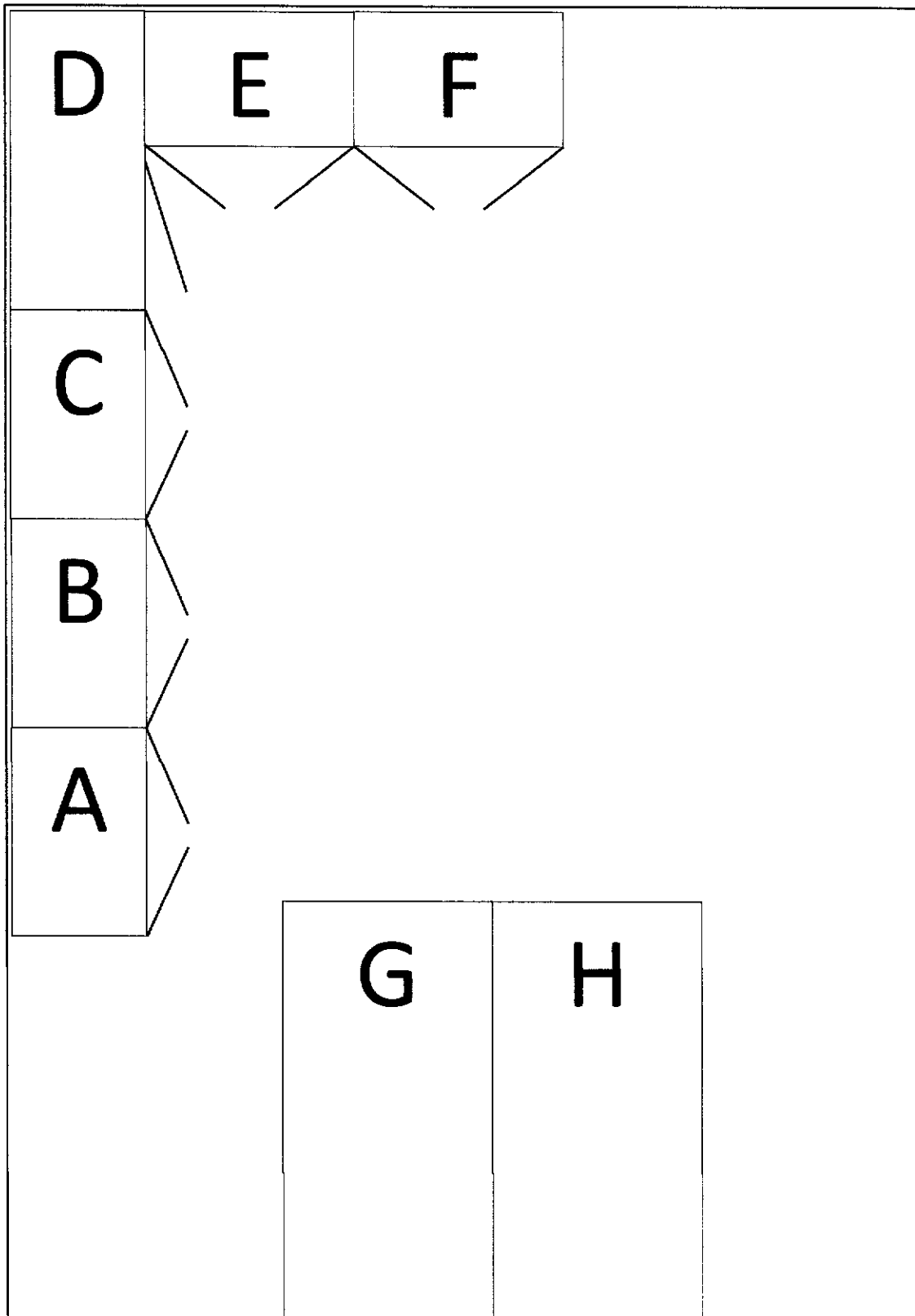

RYS. 5.1

Szafka A i C

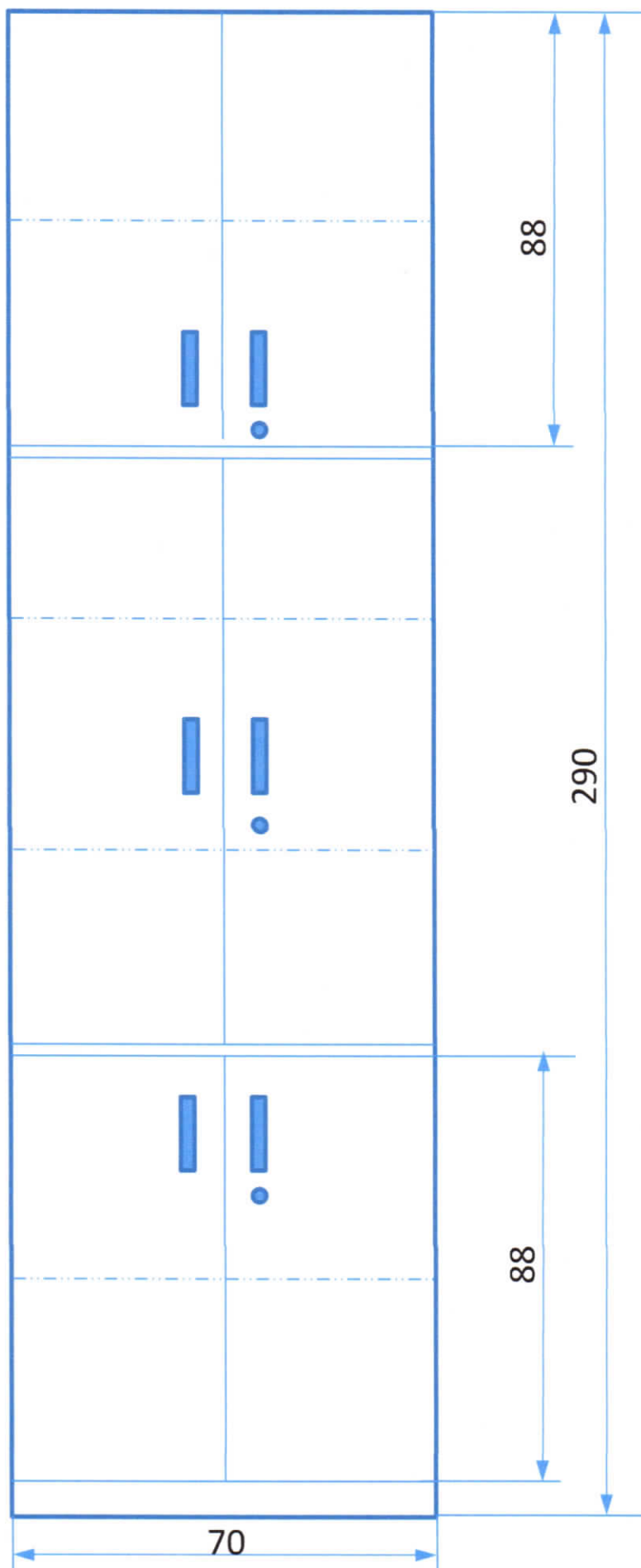

RYS. 5,2

Szafka B

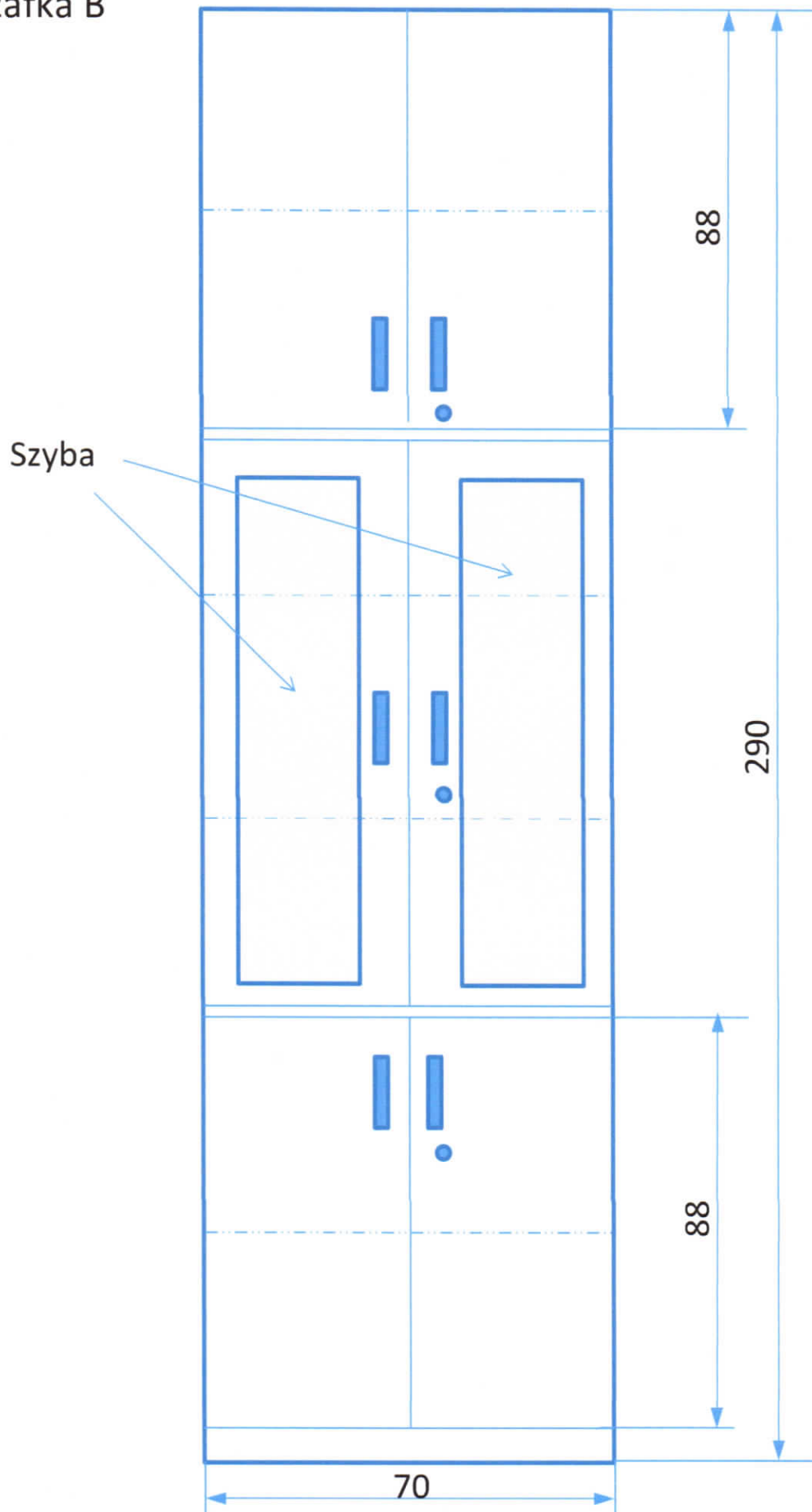

Szafka D

(ubraniowa/rogowa)

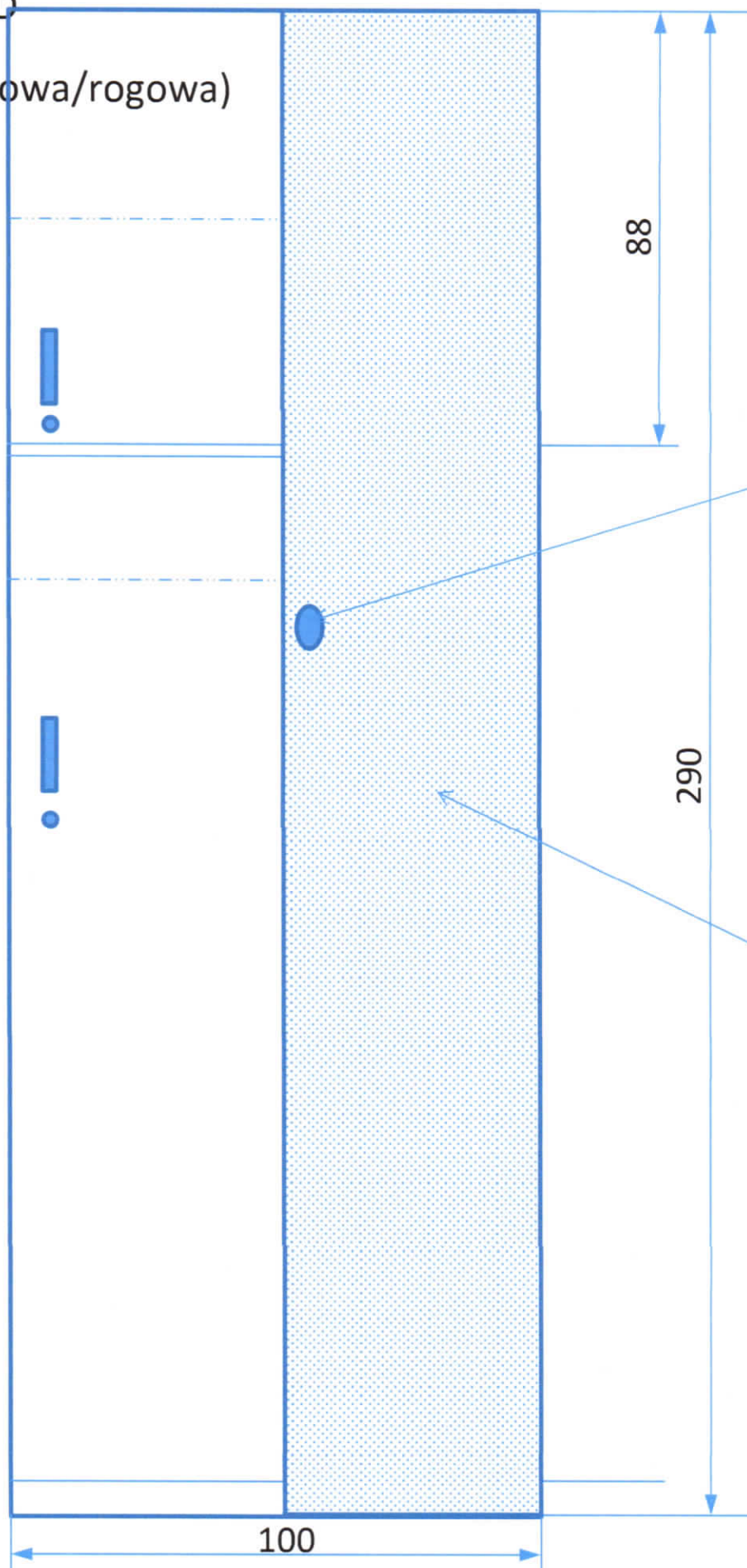

Drażek do wieszaków zamontowany
prostopadłe do drzwiczek mebli

Powierzchnia styku z szafką E

RYS. 5.4

Szafka E

(zabudowa umywalki)

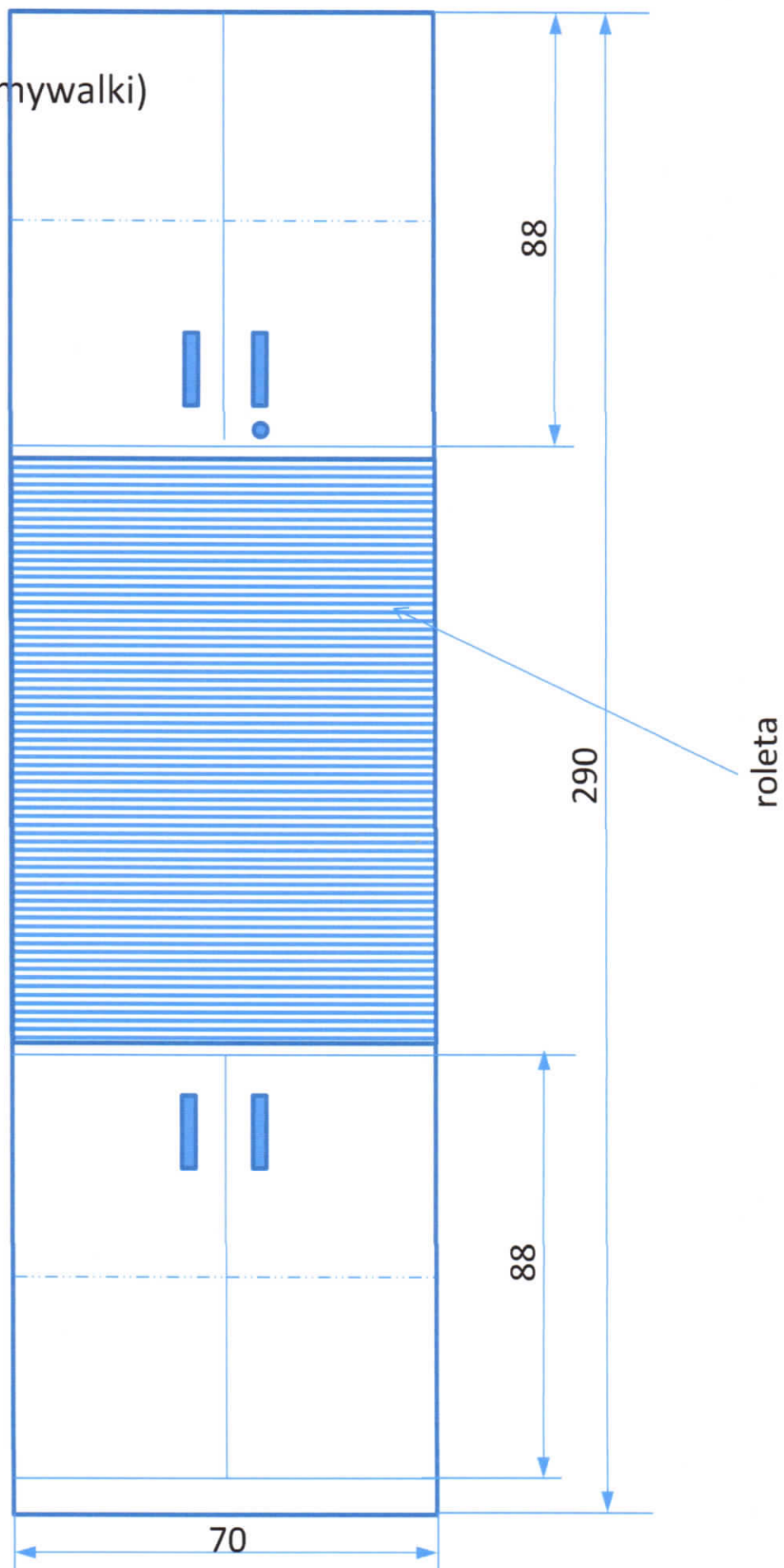

RYS. 5.5

Szafka F

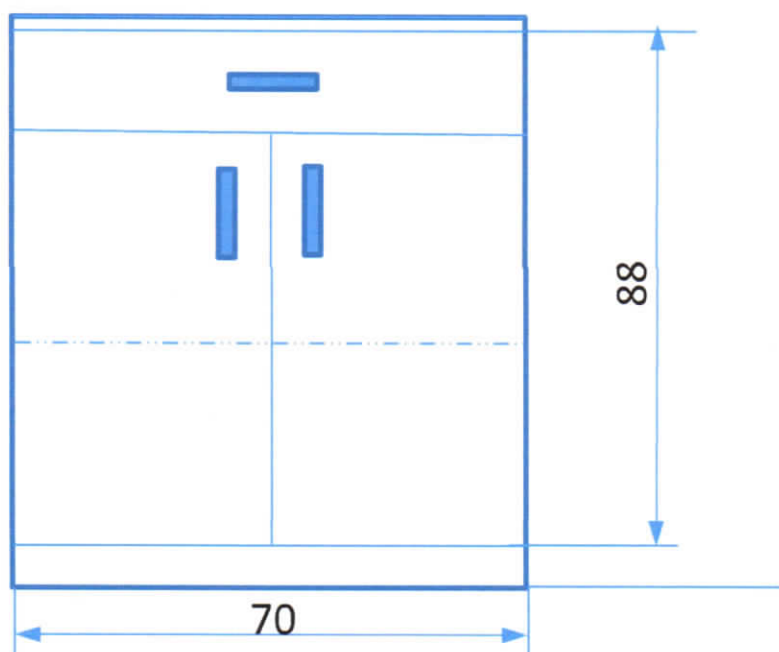

RYS. 5.6

Biurko G i H

Rzut od frontu

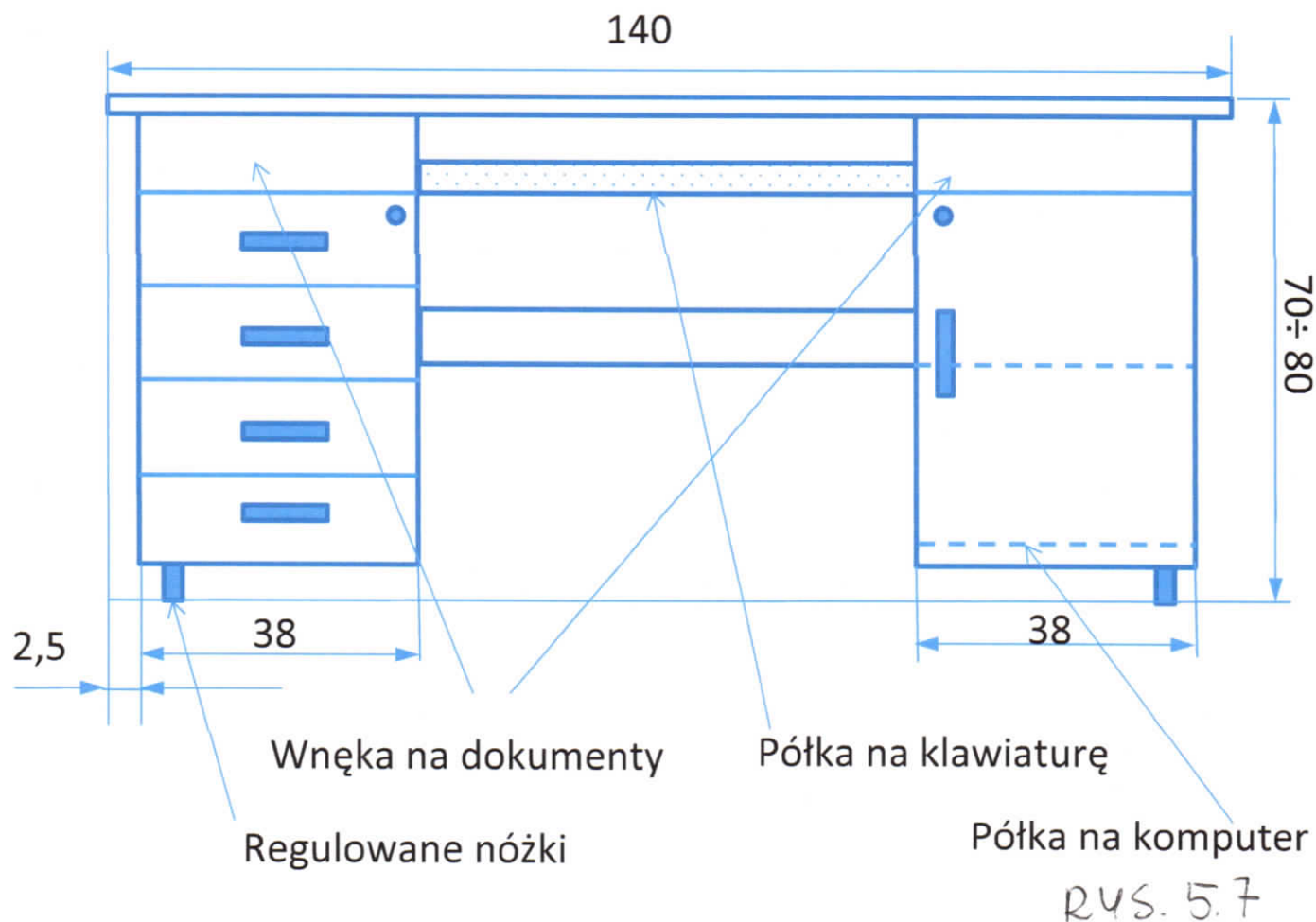

Rzut z boku

